

Fire Door *Catalog*





www.mebсутador.com



011 - 6686 2426

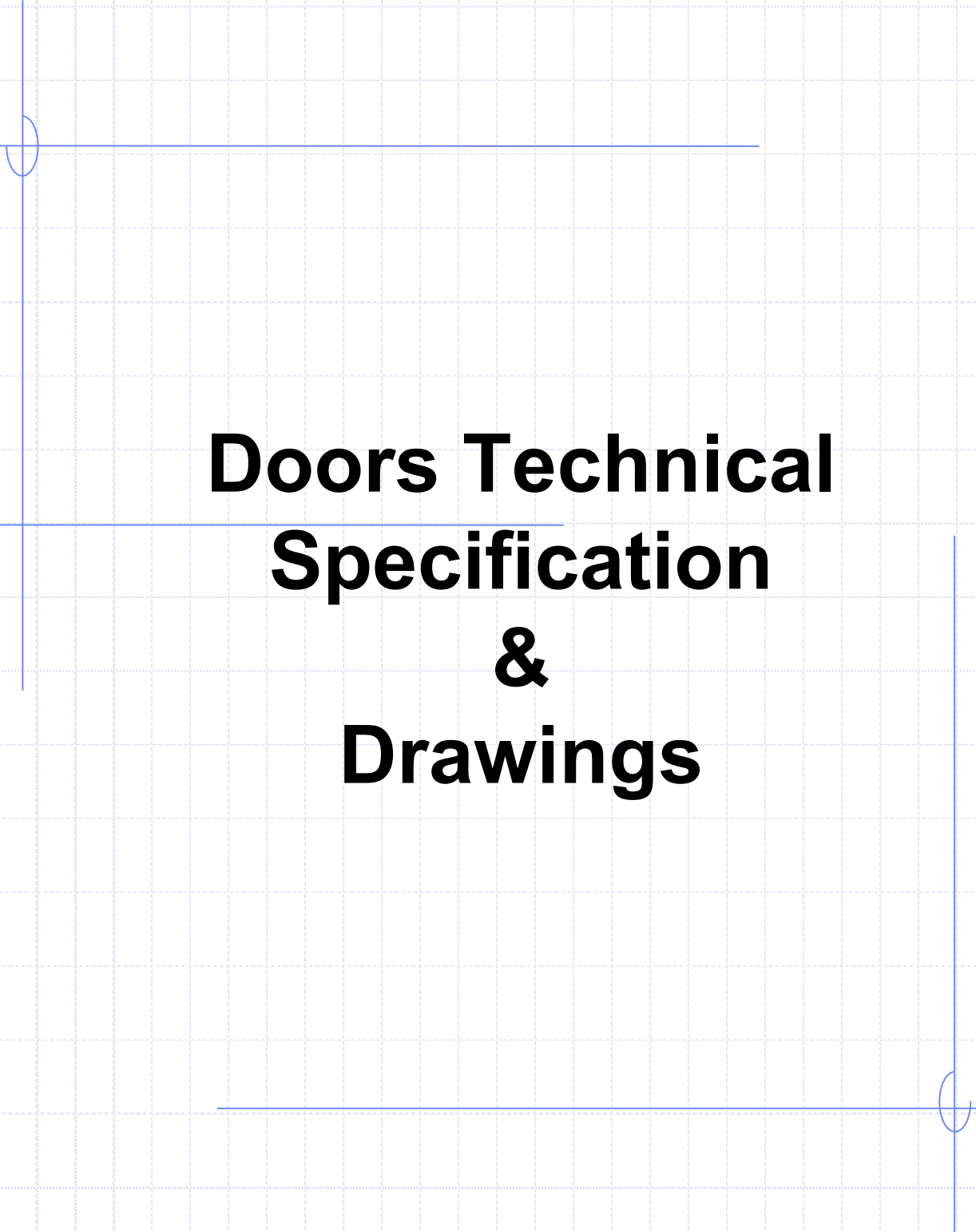

mebsuta.sales@gmail.com



Doors Technical Specification & Drawings

TECHDOR

FIRE RESISTANT DOORSET is of, solid core design, fabricated from a single piece fire resistant board finished with door surface on both sides and edged with timber lipping (for 1 hour) and metal capping (for 2 hours)

TECHDOR is tested and approved to Malaysia Standard of MS 1073 part 2 and 3 : 1996 on :

Integrity

The ability of a specimen of a doorset to contain a fire specified criteria for collapse, freedom from holes, cracks and fissures and sustained flaming on the unexposed face.

Insulation

The ability of a specimen of a doorset to restrict the temperature rise of the unexposed face below specified levels.

Cyclic movement endurance test

A doorset should be subjected to 100,000 cycles of continuous opening and closing for Single Leaf and 50,000 cycles for Double Leaves.

TECHDOOR is tested and approved with complete range of ironmongeries of various brands and models :

- Mortise lockset with stainless steel lever handle
- Card Access Lockset for Hotel
- Door closer
- Stainless steel hinges
- Door selector (for double leaves only)
- Fastening bolts (for double leaves only)

TECHDOR is tested and approved with metal frame. We also offer optional items like:

- 150mm x 300mm wire glass vision panel for 1 hour only
- Various finishes
- Decorative beadings

FRONT VIEW OF DOORSET

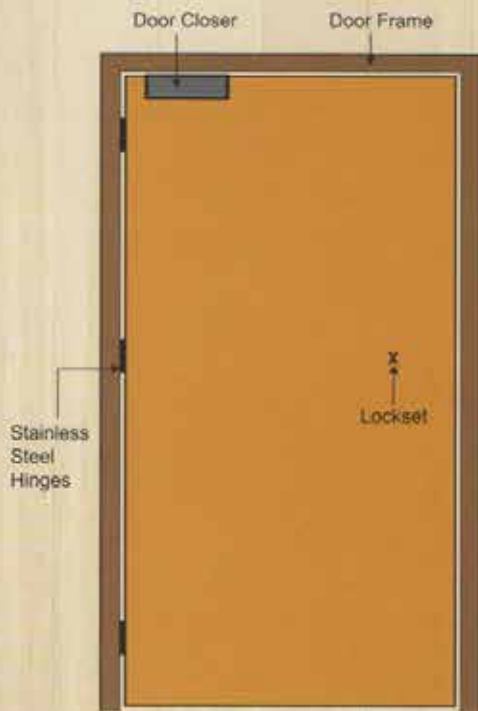

Single Leaf

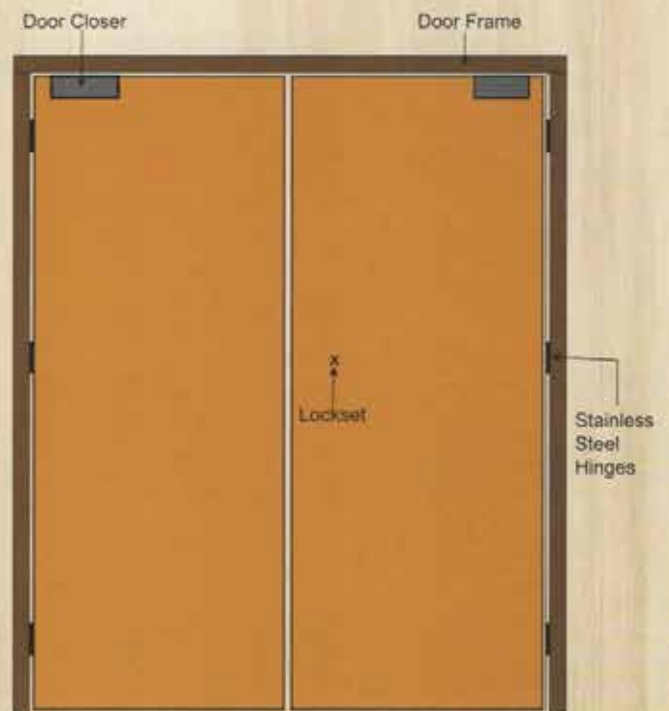

Double Leaves

One Hour Rated Single Leaf

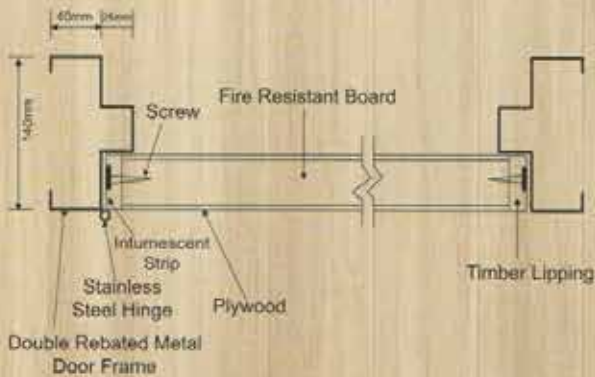

One Hour Rated Double Leaves

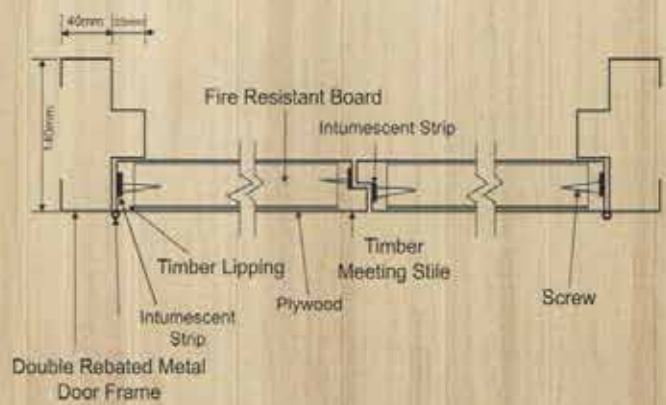

Two Hour Rated Single Leaf

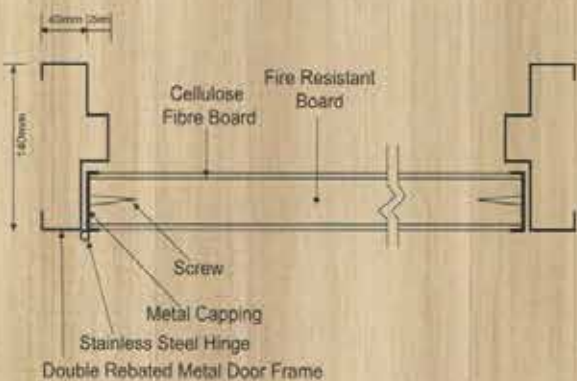

Two Hour Rated Double Leaves

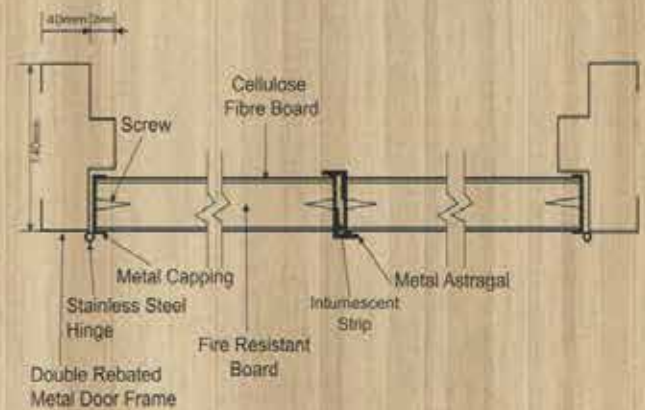



HKBM MORTISE LOCK CASE SET C/W EURO PROFILE CYLINDER & LEVER HANDLE

HKBM 6072Z Mortise Lock Case

Descriptions:

- Forend & Strike Plate Are Stainless Steel Material
- 60mm Back Set
- Reversible Latch

EN Standard: EN 12209: 2016



HKBM PC70 Euro Profile Cylinder



Descriptions:

- Single Profile Cylinder
- Solid Brass Material
- Master Keyable Cylinder

EN Standard: EN 1303: 2015

HKBM LEC9000 / SS4003 Lever Handle



Descriptions:

- Stainless Steel Material
- 8mm x 8mm Spindle Hole
- Through Mounting Screw System

EN Standard: EN 1906: 2012

* Specifications subject to change without prior notice

HEIKEN BUILDING MATERIAL CONSORTIUM SDN. BHD. (Company No. 617617-U)

Office Address:
A-09-12, Pinnacle Petaling Jaya,
Lorong Utara C, 46200, Selangor Darul Ehsan.

Tel: 603-7624 2886
Fax: 603-7624 2887



advancing architectural ironmongery
gai affiliate



HKBM DOOR CLOSER C/W REGULAR ARM & BACK CHECK FUNCTION

HKBM 073 Door Closer

EN Standard: EN 1154: 1996/A1:2002/AC:2006

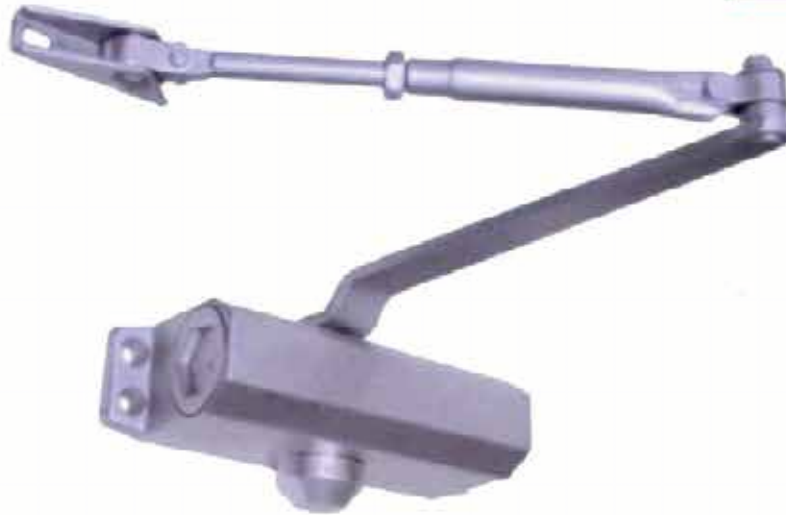

Descriptions:

- The wall mounted hydraulic door closers are ideally suited to a wide range of commercial applications.
- It is designed to suit fire rated door sets.

Specifications:

- Aluminium Alloy Material
- Standard Arm
- Back Check Function

Installation View:

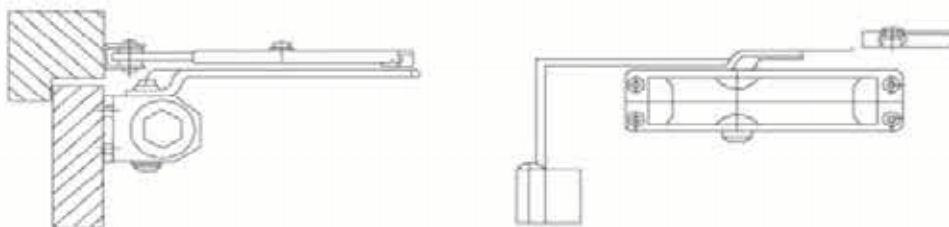

* Specifications subject to change without prior notice.

HEIKEN BUILDING MATERIAL CONSORTIUM SDN. BHD. (Company No. 617617-U)

Office Address:
A-09-12, Pinnacle Petaling Jaya,
Lorong Utara C, 46200, Selangor Darul Ehsan.

Tel: 603-7624 2886
Fax: 603-7624 2887



advancing architectural ironmongery
gai affiliate



TECHDOR STAINLESS STEEL HINGES

TECHDOR Hinges

EN Standard: EN 1935:2002/AC:2003

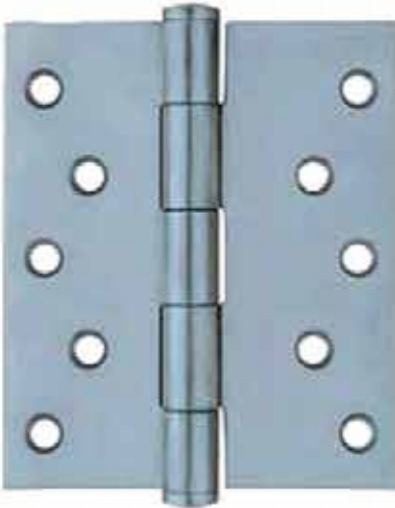

Specifications:

- Stainless Steel Hinge
- Complete with wood screws
- Size: 127 x 89 x 2.5mm

Finish:

- Satin Stainless Steel

Handle Orientation:

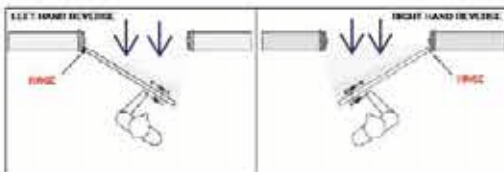

Technical Drawing:

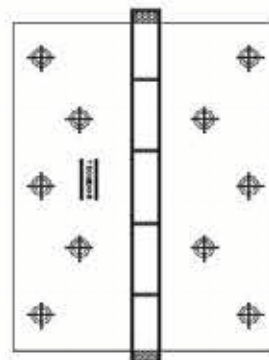

* Specifications subject to change without prior notice

HEIKEN BUILDING MATERIAL CONSORTIUM SDN. BHD. (Company No. 617617-U)

Office Address:
A-09-12, Pinnacle Petaling Jaya,
Lorong Utara C, 46200, Selangor Darul Ehsan.

Tel: 603-7624 2886
Fax: 603-7624 2887



advancing architectural ironmongery
gai affiliate



HKBM DS01 L280 Door Selector / Co-ordinator

EN 1158: 1997/A1: 2002/AC:2006



Descriptions:

- Door Selector / Co-ordinator is designed to ensure effective fire compartmentation in buildings by ensure that the individual leaves of pairs of doors with rebated meeting stiles close in the correct sequence.

Specifications:

- Stainless Steel Material
- With Roller To Reduce Door Impact
- Stainless Steel Adjusting Part

* Specifications subject to change without prior notice

HEIKEN BUILDING MATERIAL CONSORTIUM SDN. BHD. (Company No. 617617-U)

Office Address:

A-09-12, Pinnacle Petaling Jaya,
Lorong Utara C, 46200, Selangor Darul Ehsan.

Tel: 603-7624 2886

Fax: 603-7624 2887



advancing architectural ironmongery
gai affiliate



HKBM AFB 6"- L Automatic Flush Bolt

EN 12051: 2000

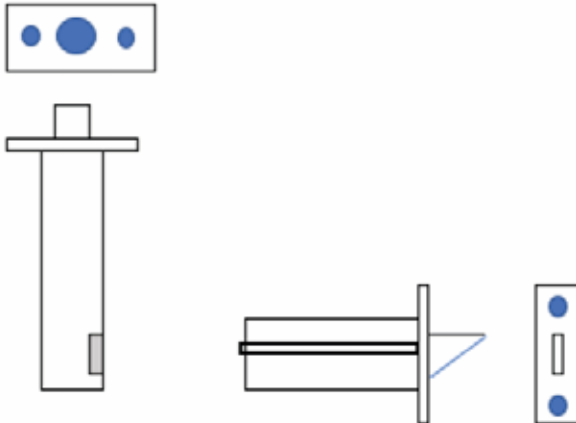

Descriptions:

- Automatic Flush Bolt allow the automatic locking and unlocking of the passive door panel of double-panel system. Users may unlock and open the active panel with the flick of a wrist, which simultaneously unlocks the passive panel allowing it to be opened. The system automatically relocks as soon as both the active and the passive panel are closed

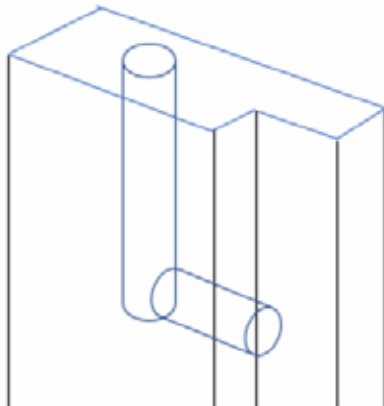

* Specifications subject to change without prior notice

HEIKEN BUILDING MATERIAL CONSORTIUM SDN. BHD. (Company No. 617617-U)

Office Address:
A-09-12, Pinnacle Petaling Jaya,
Lorong Utara C, 46200, Selangor Darul Ehsan.

Tel: 603-7624 2886
Fax: 603-7624 2887



advancing architectural ironmongery
gai affiliate